

DINING CHAIR

Thank you for purchasing this product. Please read the instructions carefully before use to ensure safe and satisfactory operation of this product.

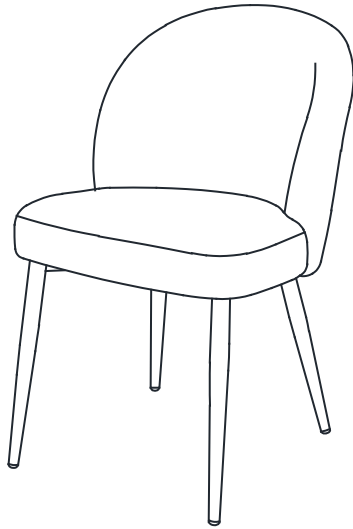

Pre-assembly preparation

Please ensure instructions are read in full before attempting to assemble this product.

Assembly time

1 Person



15 minutes



Tools Needed (Included)

Allen Key # 4



Please check the pack contents before attempting to assemble this product. A full checklist of components is given in this leaflet. If any components are missing please contact the retailer from whom you bought this product.

All assembly should be performed on flat, stable, clean and soft surface.

This product is **HEAVY**, it should be assembled as near as possible to the point of use. **TAKE CARE WHEN LIFTING** to avoid personal injury and (or) damage to the product.

The fitting pack contains **SMALL ITEMS** which should be **KEPT AWAY FROM YOUNG CHILDREN**

IMPORTANT: Retain these instructions for future reference.

Stock Code: H2123-09-XXX





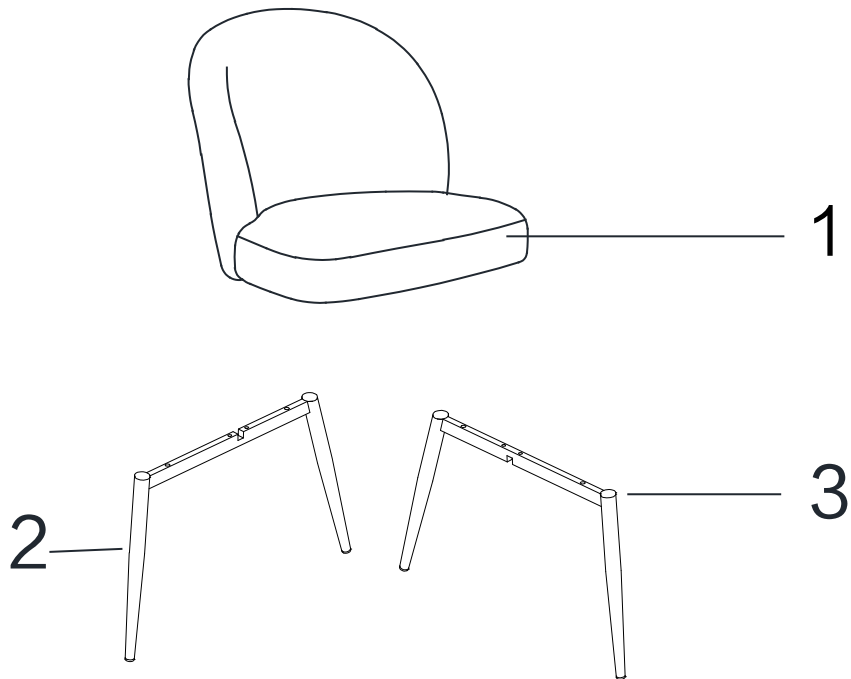

Batch: POR177007/8

Page 1 of 6

Fittings and Parts Checklist





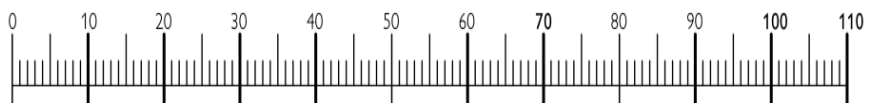

Item	Description	Qty	Item	Description	Qty
1	Back of Chair	x 1	2	Chair Leg	x 1
3	Swivel Plate	x 1			

Item	Description	Qty	Item	Description	Qty
A	Bolt M6 x 40mm 	x 4	B	Bolt M6 x 50mm 	x 4
C	Washer 6 x 16mm 	x 8	D	Cross without thread 	x 1
E	Cross with thread 	x 1	F	Allen Key 4# 	x 1



Step by Step Assembly Instructions

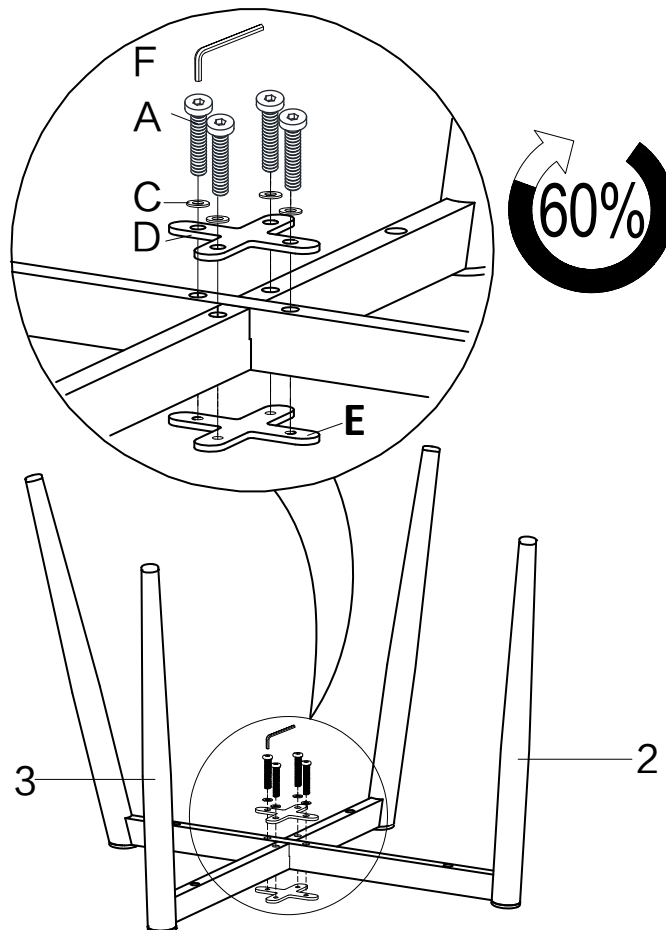
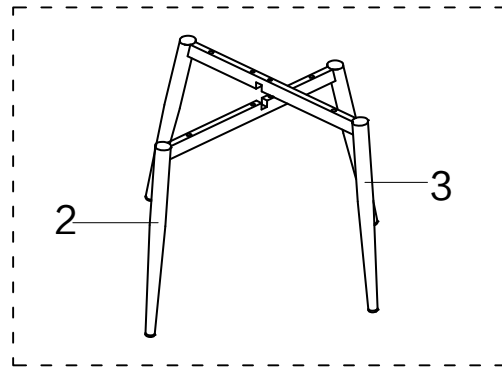

Step 1

Ax4	Cx4	Dx1	Ex1	Fx1
				
M6x40mm	6x16mm			4#



Step by Step Assembly Instructions

Step 2

Bx4  M6x50mm	Cx4  6x16mm	Fx1  4#
--	---	---

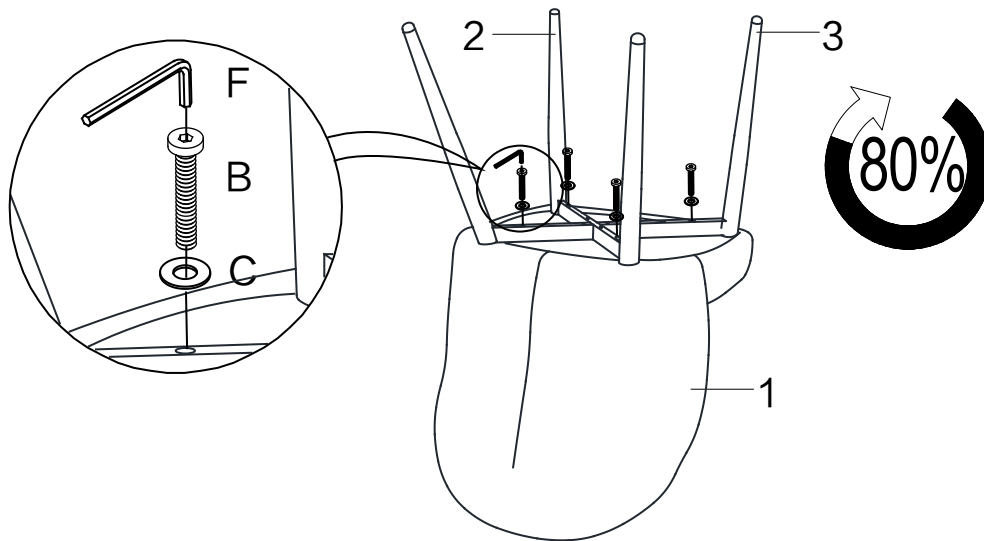

Step 3

Fx1  4#

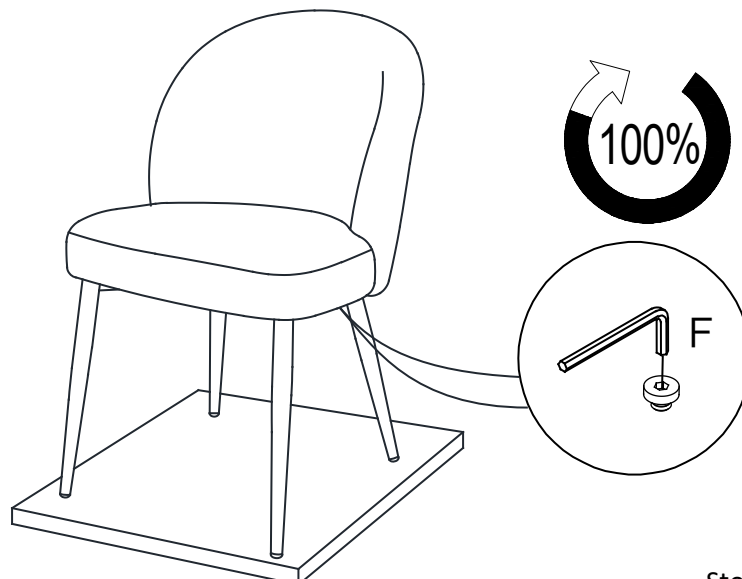

How to Care for Your Upholstered Furniture

Routine Cleaning

- Vacuum or lightly brush regularly to remove dust and dirt.
- Rub very gently to avoid changing the fabric colour.

Avoid

- Prolonged exposure to direct sunlight, which may cause fading.
- Placement near heat sources (e.g., radiators or open flames).

Spills

- Act quickly. Blot excess liquid using a white paper towel.
- Dab gently with a clean towel. Avoid soaking the material.

How to Care for Your Sintered Stone Furniture

Routine Cleaning

- Dust regularly with a clean, lint-free cloth.
- Use a soft cloth dampened with warm water and a mild, non-abrasive detergent.
- Dry immediately to avoid residue or water spots.

Avoid

- Abrasive cleaners or harsh chemicals.
- Silicone-based polishes that may leave a film.

Spills & Stains

- Wipe up all spills promptly.
- For sticky residue, use diluted soapy water and a clean sponge. Rinse and dry thoroughly.
- Avoid contact with nail polish remover, hairspray, perfume, or any solvent-based product.

Handling

- Do not stand or place excessive force on the stone surface.
- Always use coasters and placemats.

Moving & Placement of Furniture

- Always lift furniture—never drag it.
- Protect corners and surfaces during handling.
- Use help when moving heavy items.
- Ensure furniture is placed on a level surface for optimal performance.

Repair & Damage

If your furniture becomes scratched, dented, or chipped, many issues can be repaired by a qualified technician. Please contact your retailer for assistance or service recommendations.

Final Care Tips

- Periodically check all fixings to ensure they are secure. Retighten if needed.
- Follow the specific guidance per material to avoid damage.
- With proper care, your furniture will offer many years of use and satisfaction.