

# BAR STOOL

Thank you for purchasing this product. Please read the instructions carefully before use to ensure safe and satisfactory operation of this product.

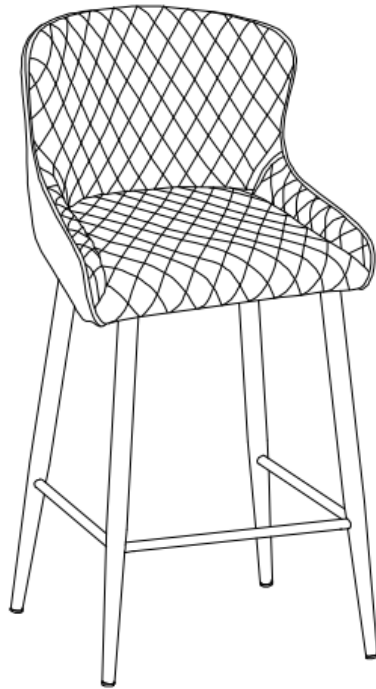

## Pre-assembly preparation

Please ensure instructions are read in full before attempting to assemble this product.

### Assembly time

1 Person



15 minutes



### Tools Needed (Included)

Allen Key # 4



Please check the pack contents before attempting to assemble this product. A full checklist of components is given in this leaflet. If any components are missing please contact the retailer from whom you bought this product.

All assembly should be performed on flat, stable, clean and soft surface.

This product is **HEAVY**, it should be assembled as near as possible to the point of use. **TAKE CARE WHEN LIFTING** to avoid personal injury and (or) damage to the product.

The fitting pack contains **SMALL ITEMS** which should be **KEPT AWAY FROM YOUNG CHILDREN**

**IMPORTANT:** Retain these instructions for future reference.

Stock Code: H1001-09BS-XXX



Batch: POR174812

Page 1 of 4

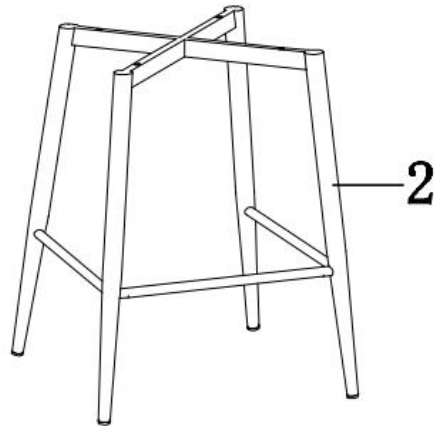
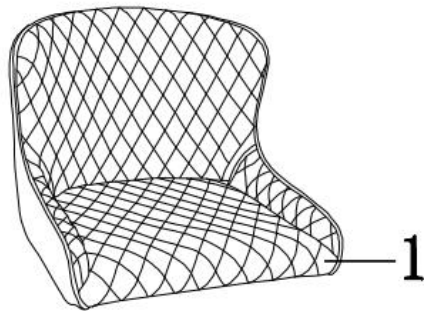
# Fittings and Parts Checklist



Item	Description	Qty	Item	Description	Qty
1	Back of Chair	x 1	2	Chair Leg	x 1

Item	Description	Qty	Item	Description	Qty
A	Bolt M6 x 50mm 	x 4	B	Washer $\varnothing 6 \times \varnothing 14\text{mm}$ 	x 4
C	Allen Key #4 	x 1			





---

# Step by Step Assembly Instructions

---

## Step 1

<b>AX4</b>  <b>M6X50mm</b>	<b>BX4</b>  <b>ø6Xø14mm</b>	<b>CX1</b>  <b>4#</b>
---	--	--

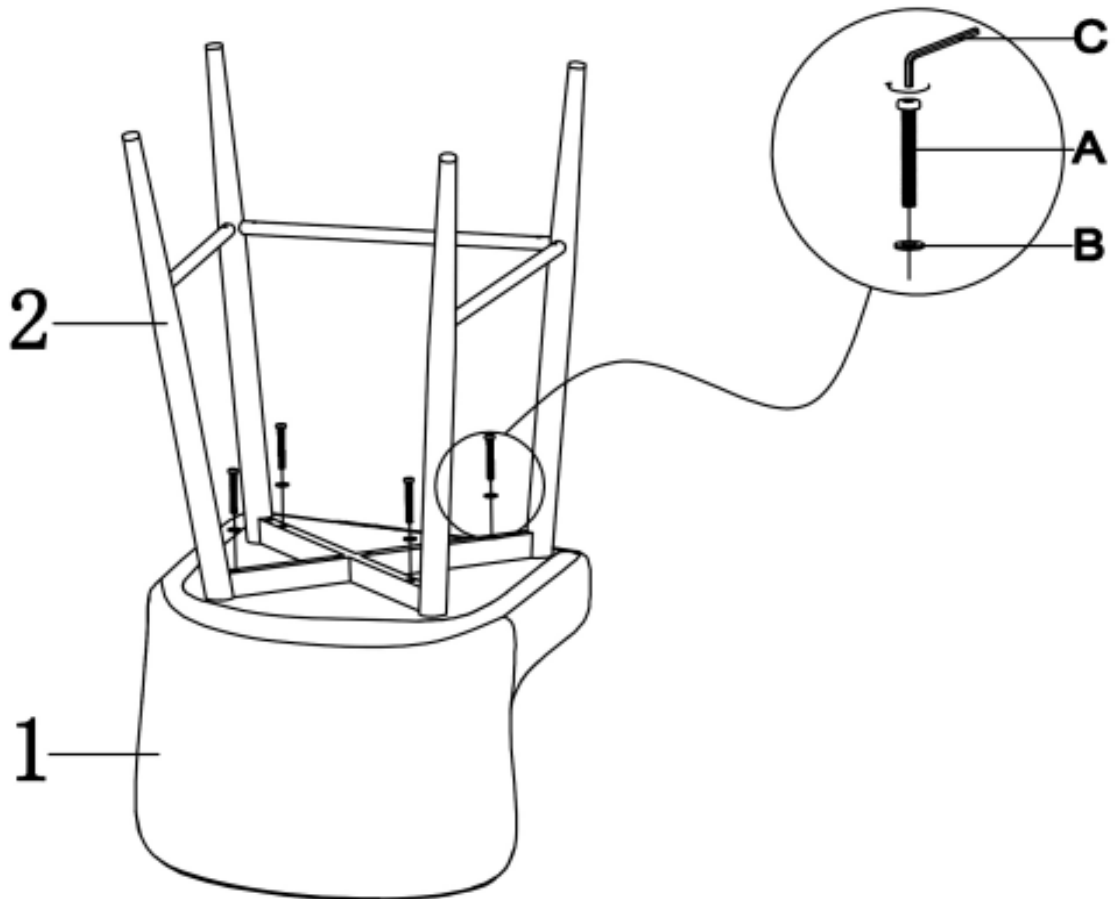

---

# Care and Maintenance

---

## **How to care for your glass furniture**

Use a glass cleaner or soapy water for cleaning. Do not use anything abrasive as this may damage the surface of the product.

## **How to care for your melamine furniture**

The melamine coated surfaces of furniture do not usually need a great deal of cleaning. These sealed surfaces are easily cared for. Clean off slightly dirty surfaces with a moistened cloth or sponge. Dirtier surfaces can be cleaned with a little water and gentle cleaning agent or soap solution.

## **How to care for your metal furniture**

Dust with a clean, soft dry cloth. Frequent dusting will remove abrasive build up, which can damage the finish over time. For stubborn stains, use a soft damp cloth and then revert back to the soft dry cloth. Spray polishes and solvents should not be used as they dissolve the protecting lacquer and allow oxidation of the genuine base material.

## **How to care for your upholstered furniture**

The upholstery should not be exposed for long periods to direct sunlight as this may cause fading and deterioration of the cover material. Protect from exposure to sources of heat such as radiators or open flames.

It is recommended to give the upholstery a frequent vacuuming or light brushing.

It is very important to rub very gently to avoid colour change. This proper cleaning will prevent build-up of dust, soil and oils which can be damaging to the leather. In the event of a spillage it is imperative to act quickly. Carefully soak up any excess liquid, ideally using the edge of a white paper towel, then dab gently with a fresh towel taking care to avoid soaking in or spreading the remaining liquid.

## **How to care for your wood furniture**

Dust with a clean, dry lint free cloth. Frequent dusting will remove abrasive build up, which can damage the finish over time. Spray polishes are best avoided as they contain silicones which may spoil the furniture's surface when building up over time.

Make sure all surfaces are protected from heat and liquids by mats and coasters. Wipe up spills immediately and ensure that a mat or pad is placed under paper if you are writing.

Our furniture will endure most temperatures in the home but it is best to avoid placing furniture next to heat sources such as radiators or fires. Be particularly careful with solid wood as the lack of humidity caused by home heating can cause damage such as warping.

## **WARNING**

Never drag furniture when moving it. Always lift it.

Periodically check all fixings to ensure none have come loose. Re-tighten when necessary.

Please take care when handling or moving the furniture as careless handling may cause damage or injury.

Furniture can be dangerous if incorrectly assembled. Assembly should be carried out by a competent person.

No liability will be accepted for damage or injury caused by incorrectly installed or assembled furniture.

It is recommended to seek assistance when moving a heavy object. Take care when lifting to avoid personal injury and (or) damage to the product.

It is recommended that before moving a heavy object to a new location it is completely dis-assembled to avoid personal injury or damage to the furniture. Please be careful to retain all fittings when doing this.

**PLEASE KEEP THESE INSTRUCTIONS FOR FUTURE REFERENCE**

Stock Code: H1001-09BS-XXX

Batch: POR174812

Page 4 of 4